

M14X150 Brass Insert

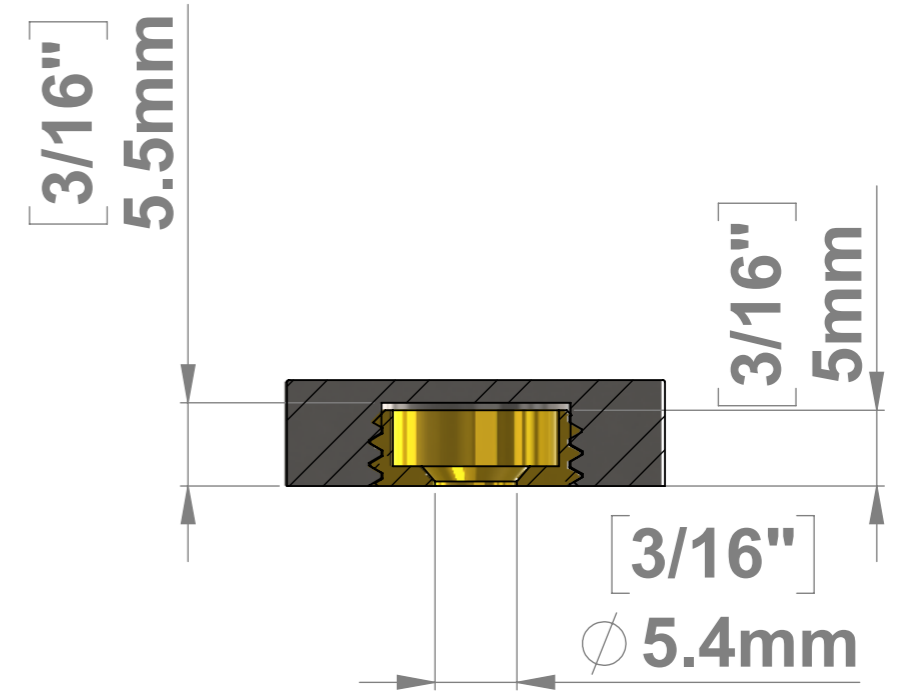

SECTION A-A

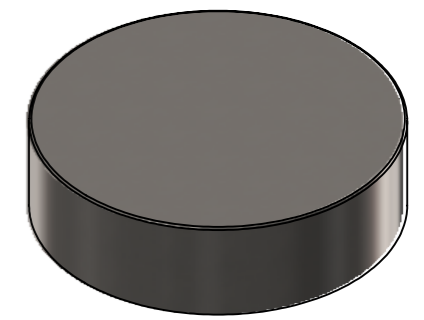
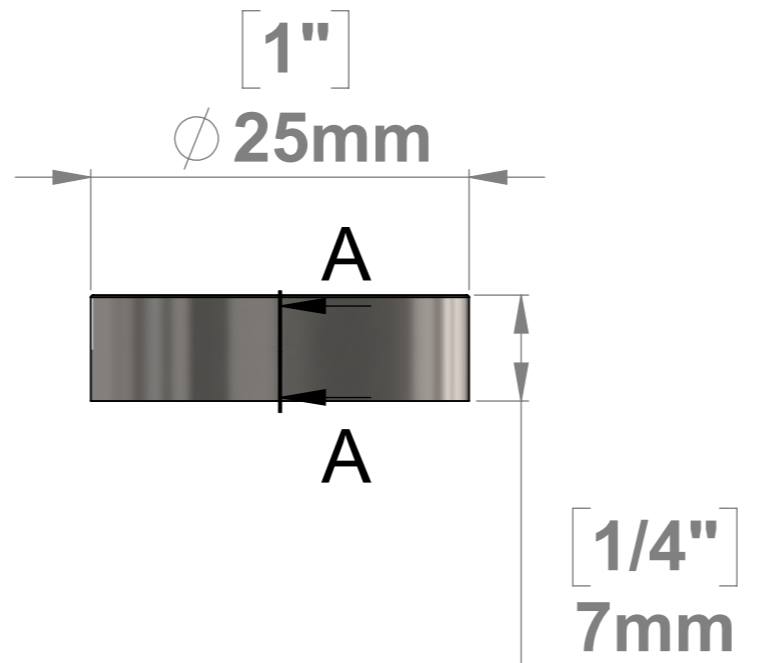
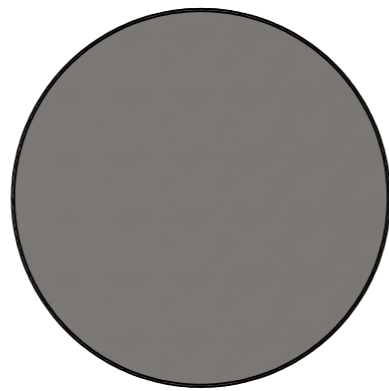
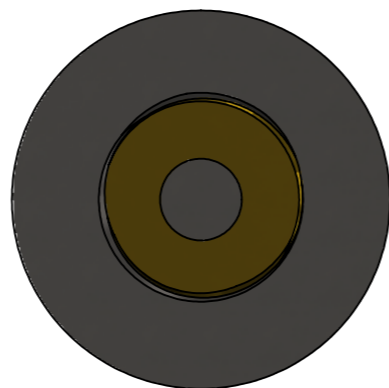

Title : SC100T316			Scale : 2:1		Mbs R&D	
			Sizes : Letter Landscape		Customer:	
	Mbs Standoffs 5046 W Linebaugh Ave Tampa, FL 33624 USA 1 (813) 938-6025	Material:		Finish		Qty :
		N°programme laser		N°prog. Mécanum.		Rep :
						N° Plan : FAH25-12