

Maximum Thickness

1/2" 12,8mm

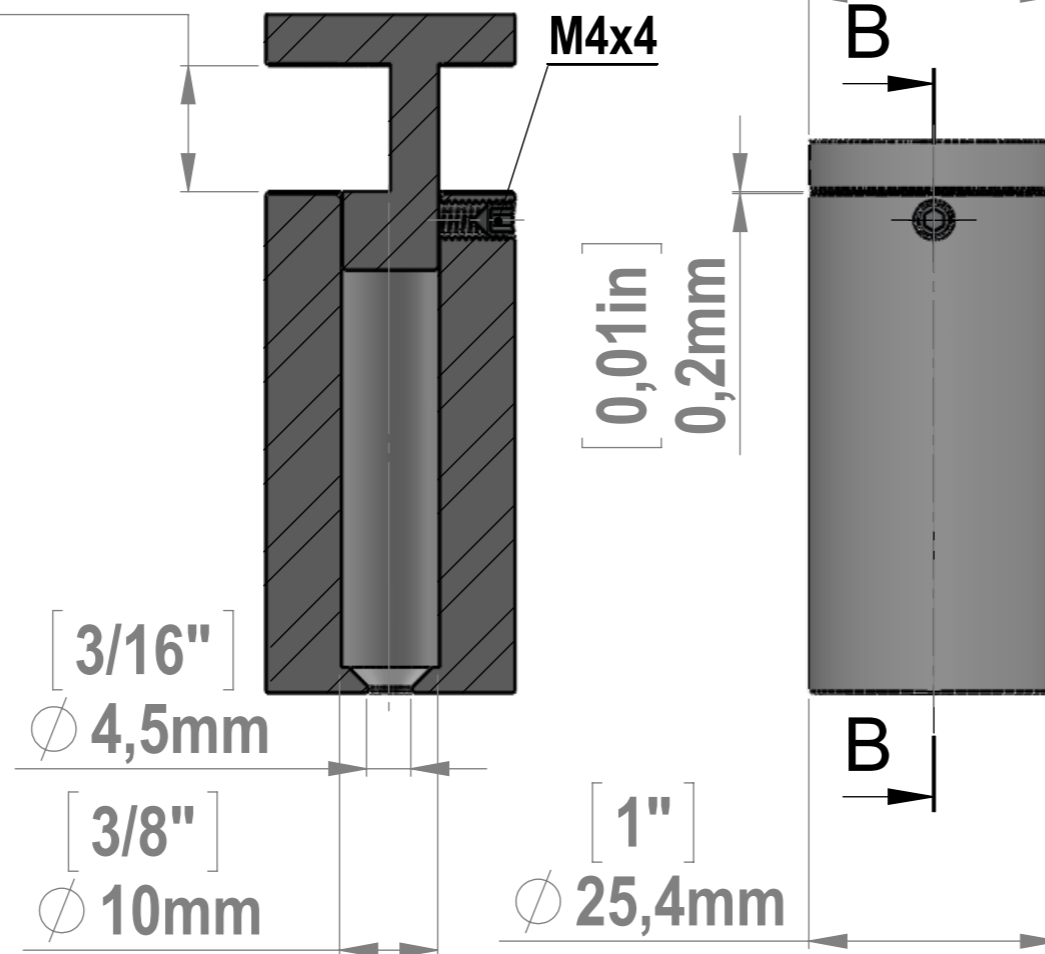

SECTION A-A
SCALE 1.3 : 1

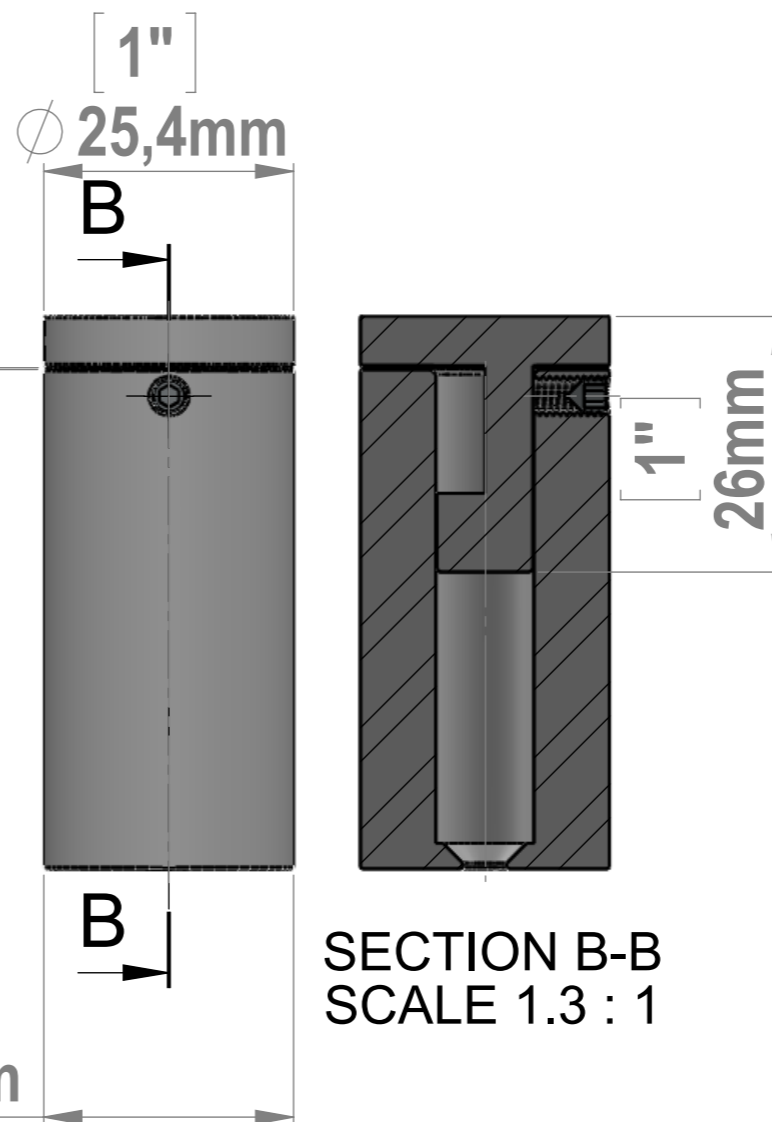

SECTION B-B
SCALE 1.3 : 1

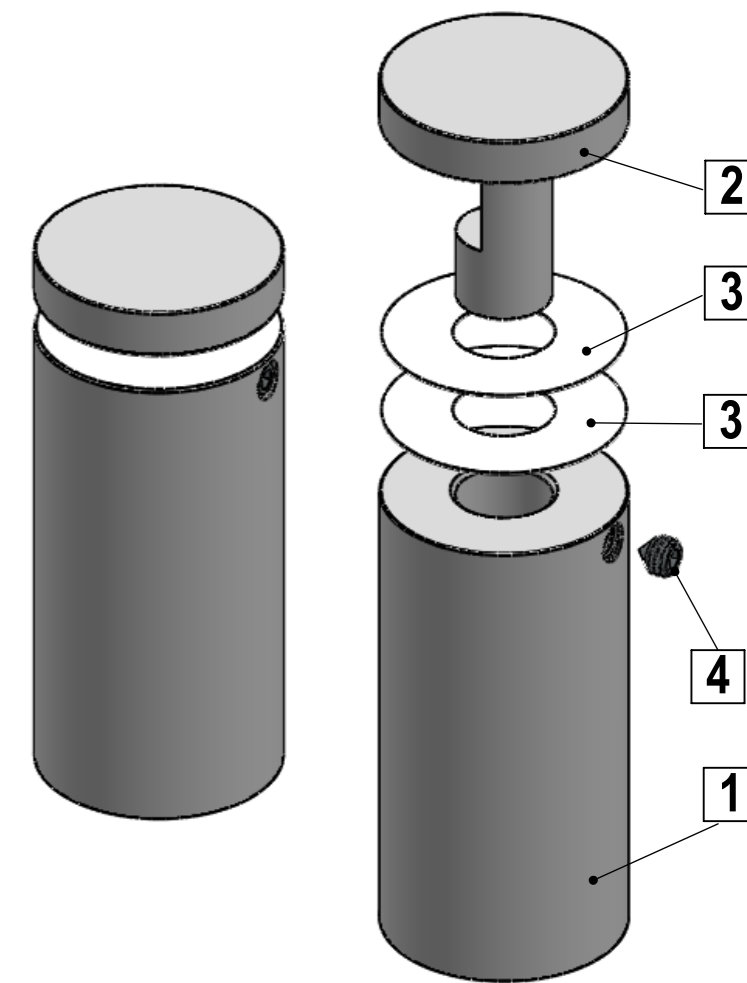

ITEM NO.	PART NUMBER	DESCRIPTION	QTY.
1	EG100-200_Body		1
2	EG100-100_Head		1
3	EG100_Nylon-Washer		2
4	Set_Screw_M4x4mm		1

Title : EG100-200		Scale : 1.3:1		Mbs R&D	
		Sizes : Letter Landscape		Customer:	
Material:		Finish		Qty :	Rep :
N°programme laser		N°prog. Mécanum.		N° Plan : EG100-200	



Mbs Standoffs
6420 Benjamin Rd
Tampa, FL 33634
USA
813-938-6025